

DANUBE

GLAZED PORCELAIN | FLOOR & WALL TILES

STONE | SPECKLE | ABSOLUTE



DANUBE



SEVEN COLOURS



TWO SIZES



THREE FINISHES

This terrazzo effect glazed porcelain range replicates the real thing, with an eye-catching speckled effect suitable for both wall and floor applications. Available in seven striking colours; try the Blue, Coral and Green for a pop of colour or the muted tones of White, Beige, Grey or Anthracite for a timeless design statement. Our Danube range is the full package with co-ordinating skirting tiles also offered, and a Grip+ 2cm option available in White, Beige and Grey, allowing tiling to be carried through from indoor to outdoor, to create an engaging and seamless look.







Colours & Product Codes

V2: Low to Moderate Shade Variation

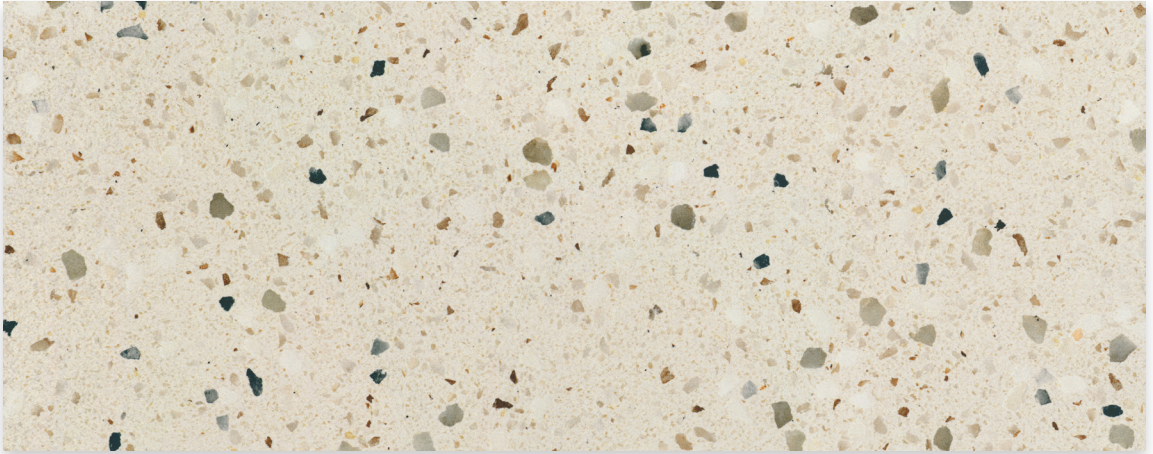

WHITE (LRV: 55) (PEI: IV)

Product Code - All Sizes: (L) DAN01L | Product Code - 592x592mm: (N) DAN01N + (E) DAN01E 2cm

Fitting Code - All Skirting: (L) DAN1LS | Fitting Code - 592x95mm Skirting: (N) DAN1NS

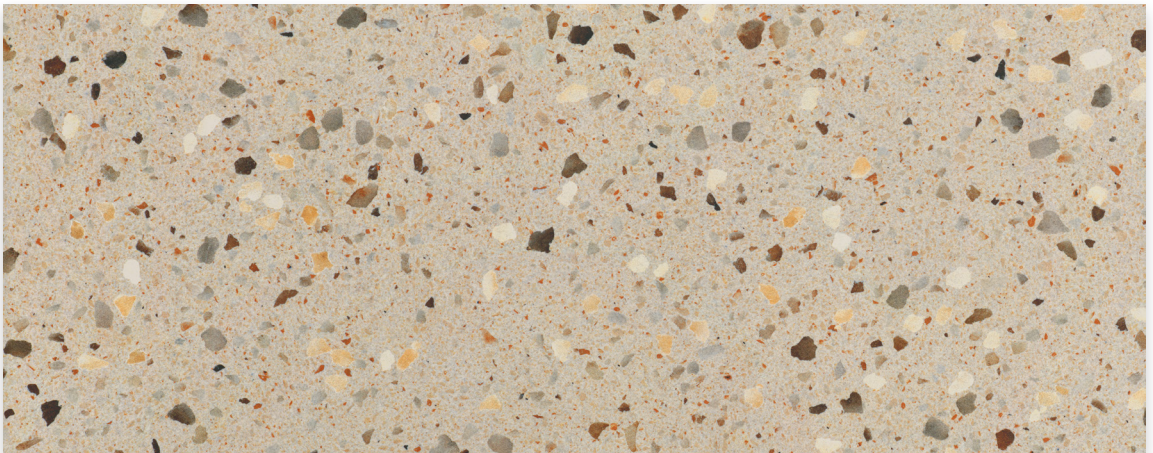

BEIGE (LRV: 42) (PEI: IV)

Product Code - 592x592mm: (N) DAN02N + (L) DAN02L + (E) DAN02E 2cm

Fitting Code - 592x95mm Skirting: (N) DAN2NS + (L) DAN2LS



GREY (LRV: 39) (PEI: IV)

Product Code - 592x592mm: (N) DAN03N + (L) DAN03L + (E) DAN03E 2cm

Fitting Code - 592x95mm Skirting: (N) DAN3NS + (L) DAN3LS



Colours & Product Codes

V2: Low to Moderate Shade Variation

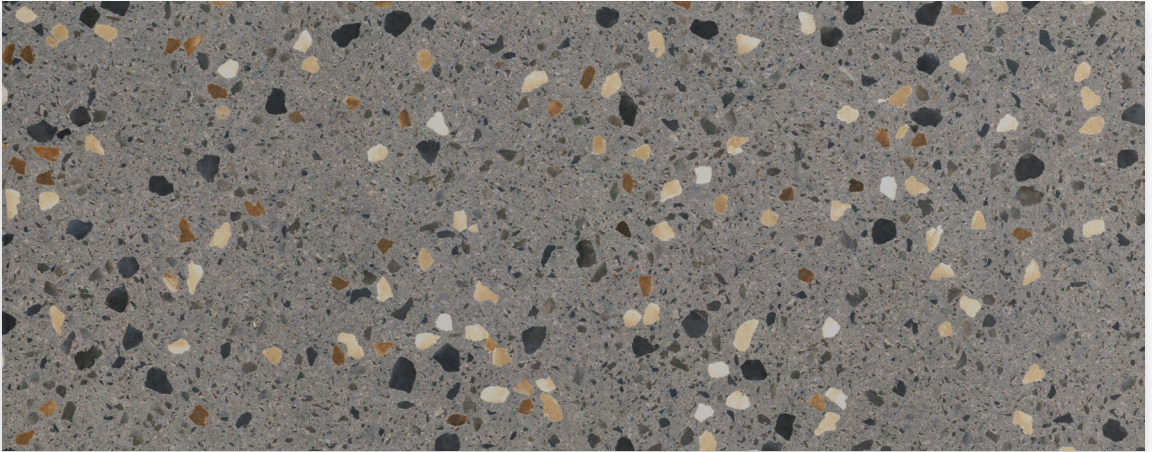

ANTHRACITE LRV: 16 PEI: III

Product Code - 592x592mm: N DAN04N + L DAN04L

Fitting Code - 592x95mm Skirting: N DAN4NS + L DAN4LS

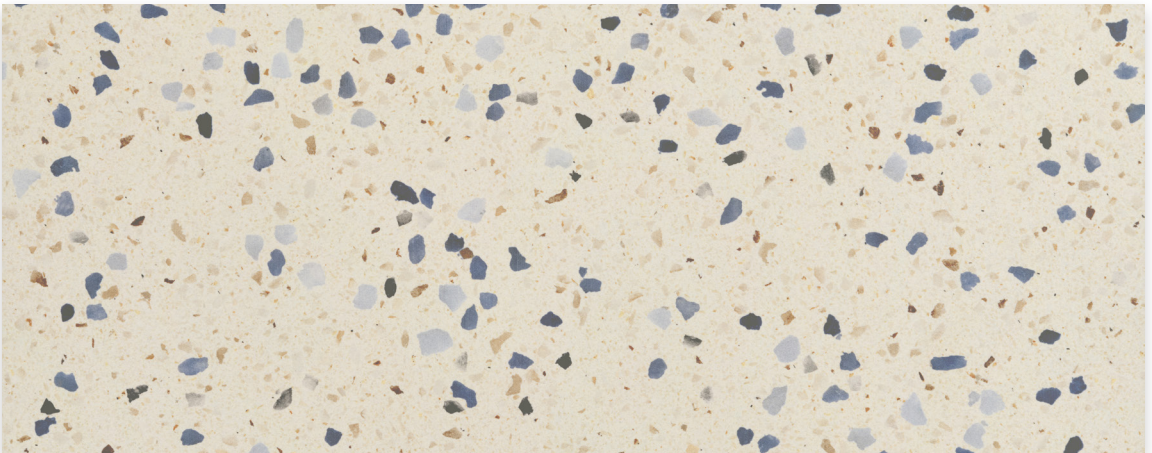

BLUE LRV: 53 PEI: IV

Product Code - All Sizes: L DAN05L | Product Code - 592x592mm: N DAN05N

Fitting Code - All Skirting: L DAN5LS | Fitting Code - 592x95mm Skirting: N DAN5NS

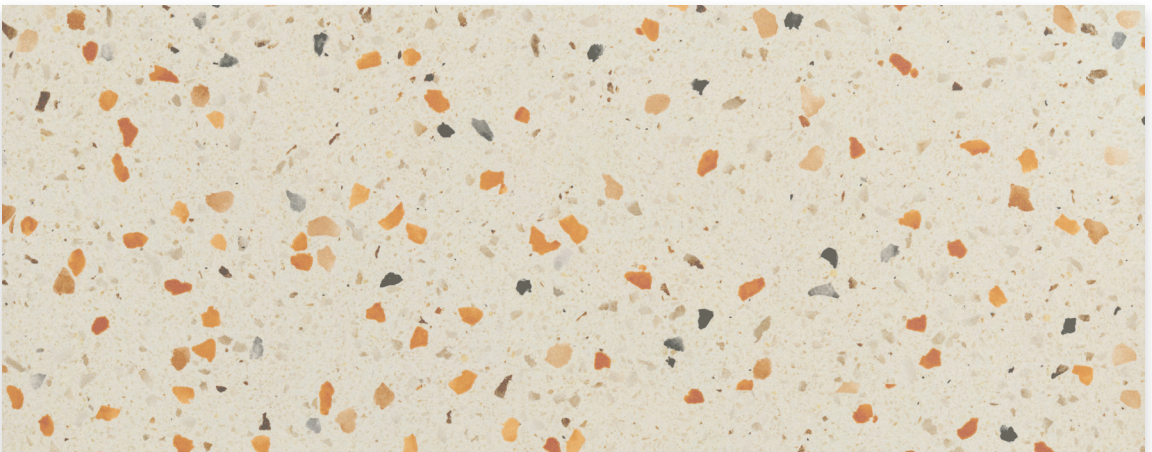

CORAL LRV: 53 PEI: IV

Product Code - All Sizes: L DAN06L | Product Code - 592x592mm: N DAN06N

Fitting Code - All Skirting: L DAN6LS | Fitting Code - 592x95mm Skirting: N DAN6NS



Colours & Product Codes

V2: Low to Moderate Shade Variation

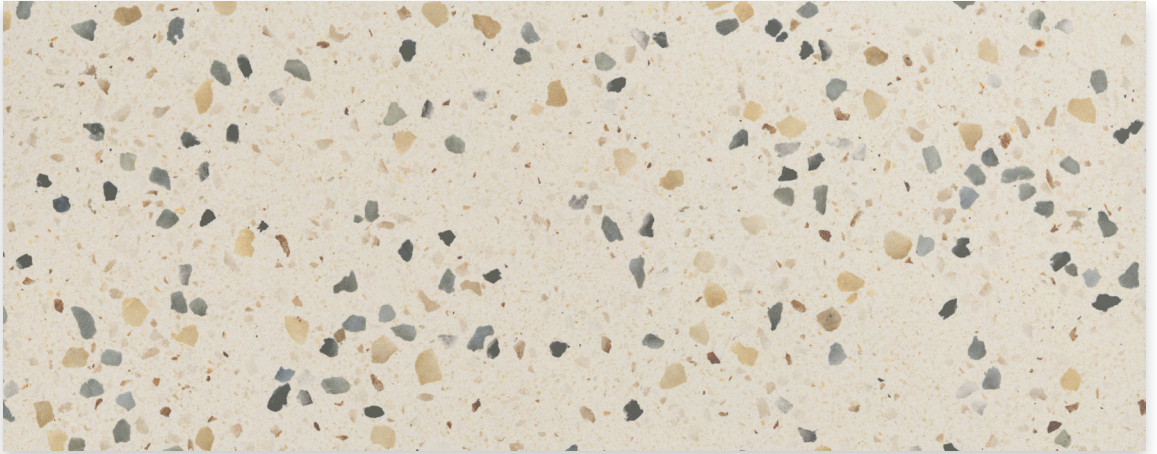

GREEN LRV: 53 PEI: IV

Product Code - All Sizes: **L** DAN07L | Product Code - 592x592mm: **N** DAN07N

Fitting Code - All Skirting: **L** DAN7LS | Fitting Code - 592x95mm Skirting: **N** DAN7NS





Size Formats

Sizing & Packing Information

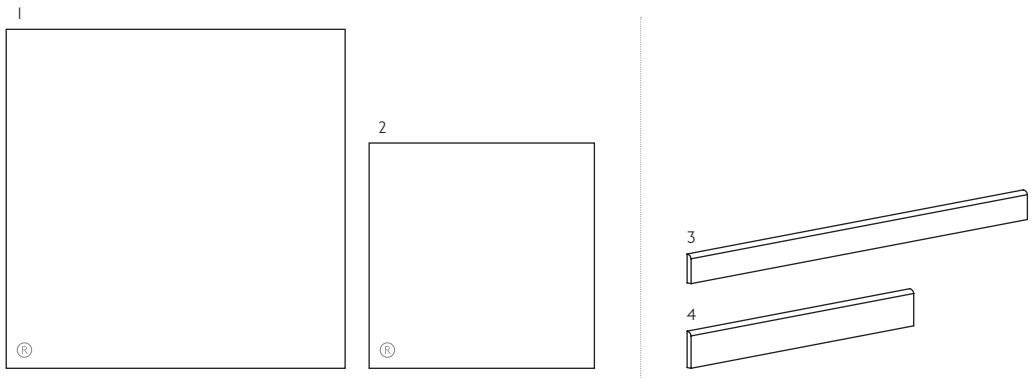

#	Size	Thickness	Finish	Structure	Class	Pcs / Box	M2 / Box	Kg / Box
1	889x889mm	10.5mm	(L) Lapato	-	Bla	1 Tile	0.79 m ²	19.40 kg
2	592x592mm	10.5mm	(N) Natural	-	Bla	3 Tiles	1.07 m ²	24.40 kg
			(L) Lapato	-	Bla	3 Tiles	1.07 m ²	24.40 kg
		20mm	(E) Grip+ 2cm	-	Bla	2 Tiles	0.71 m ²	32.00 kg

#	Fitting	Thickness	Finish	Structure	Class	Pcs / Box	LM / Box	Kg / Box
3	889x75mm Round Top Skirting	10.5mm	(L) Lapato	-	Bla	13 Tiles	11.56 lm	21.19 kg
4	592x95mm Round Top Skirting	10.5mm	(N) Natural	-	Bla	18 Tiles	10.66 lm	24.84 kg
			(L) Lapato	-	Bla	18 Tiles	10.66 lm	24.84 kg

Note: (R) Rectified Edge. Class Bla: Glazed Porcelain Tiles. For more information please see the suitability advice given in the technical section. All sizes indicated are metric modular. All sizes shown are nominal. For the most up-to-date size, colour and finish availability, please visit our website - www.johnson-tiles.com.



Anthracite Natural 592x592x10.5mm - DAN04N



Specification

Range	Finish	Wall Suitability	Floor Suitability	Wet Barefoot	CSV	Material / Class
Danube	N Natural	Internal & External	Internal Only	-	V2	Glazed Porcelain [Bla]
	L Lapato	Internal & External	Internal Only	-	V2	Glazed Porcelain [Bla]
	E Grip+ 2cm	Internal & External	Internal & External	Yes	V2	Glazed Porcelain [Bla]

Floor Values

Finish	Colour	PTV (4S)	PTV (TRL)	R Value	Wet Ramp	PEI	Traffic
N Natural	Anthracite	Dry 36+ Wet 36+	-	R10	A	III	Light Commercial
	All Other Colours	Dry 36+ Wet 36+	-	R10	A	IV	Commercial
L Lapato	Anthracite	Dry 36+ Wet 0 - 24	-	-	-	III	Light Commercial
	All Other Colours	Dry 36+ Wet 0 - 24	-	-	-	IV	Commercial
E Grip+ 2cm	Anthracite	Dry 36+ Wet 36+	Wet 36+	R12	C	III	Light Commercial
	All Other Colours	Dry 36+ Wet 36+	Wet 36+	R12	C	IV	Commercial

Physical Properties

Test & Standard	Requirement	Test Result	Test & Standard	Requirement	Test Result
Length / Width EN ISO 10545 - 2	$\pm 0.6\% \leq \pm 2\text{mm}$	$\pm 0.3\%$	Modulus of Rupture EN ISO 10545 - 4	Min. 35N / mm ²	$\geq 35\text{N} / \text{mm}^2$
Thickness EN ISO 10545 - 2	$\pm 5\% \leq \pm 0.5\text{mm}$	$\pm 3\%$	Thermal Shock EN ISO 10545 - 9	Pass	Pass
Straightness of Side EN ISO 10545 - 2	$\pm 0.5\% \leq \pm 1.5\text{mm}$	$\pm 0.3\%$	Frost Resistance EN ISO 10545 - 12	Resistant	Resistant
Rectangularity EN ISO 10545 - 2	$\pm 0.5\% \leq \pm 2\text{mm}$	$\pm 0.3\%$	Chemical Resistance EN ISO 10545 - 13	Min. Class B	Class A
Surface Flatness EN ISO 10545 - 2	$\pm 0.5\% \leq \pm 2\text{mm}$	$\pm 0.3\%$	Stain Resistance EN ISO 10545 - 14	Min. Class 3	Pass
Water Absorption EN ISO 10545 - 3	$\leq 0.5\%$	$\leq 0.1\%$	Fire Rating	-	Class A I FL Non Combustible
Weight / M²	24.56 kg 10.5mm thick	45.21 kg 20mm thick			

Sustainability Information

Range	Material / Class	EPD	Recycled Content of the Tiles	Recycled Content of the Packaging	Recyclable Content of the Packaging
Danube	Glazed Porcelain [Bla]	Yes	Up to 10%	Up to 100% (Boxes)	Up to 100%

Note: Due to the manufacturing process of all floor tiles there may be small variations in slip resistance. Given this, please refer to our website for the most up-to-date information. The slip resistance properties of a surface can only be maintained with the implementation of an effective regular cleaning and maintenance regime. The frequency of cleaning should be determined by the property manager based on the potential level of surface contaminants. The need for an additional regular cleaning and maintenance regime is further heightened when tiles are used for external floor and wet barefoot applications.

Please contact our technical helpline for specification and installation advice. All glazed porcelain [Bla] products shown in this range overview conform to BS EN 14411.

CSV: Colour Shade Variation. PTV (4S): Pendulum Test Value - Slider 96. PTV (TRL): Pendulum Test Value - Slider 55. R Value (DIN 51130). Wet Ramp (DIN 51097).

PEI: Porcelain Enamel Institute. EPD: Environmental Product Declaration. For a full company sustainability overview please visit www.johnson-tiles.com/about/sustainability.

Important Information

During the manufacturing process of ceramic and porcelain tiles, some variation in shade and pattern can occur. Before fixing any tiles, several boxes should be opened and their contents mixed to ensure that size, colour, shade and patterning are acceptable. The tiles shown are quality products and conform to the physical properties listed. For a comprehensive colour, size and finish overview along with full technical and sustainability information for all of the product shown in this product presenter, please visit our website - www.johnson-tiles.com.

- All sizes shown are metric modular.
- For specific suitability details please contact our technical department.
- Johnson Tiles cannot accept responsibility for tiles that have been fixed.
- Every effort has been made to ensure the accuracy of the information given.
- Johnson Tiles reserves the right to change specification and availability information without prior notice.
- Nothing in these statements does/will affect the statutory rights of the consumer.

© Johnson Tiles, Johnson, Absolute and Material Lab are registered trademarks and together with Kerastar and product names are the trademarks of H&R Johnson Tiles Limited and licensed to Norcros Group (Holdings) Limited trading as Johnson Tiles. © 2023 Johnson Tiles. All rights reserved.



All product technical values quoted in this product presenter are supported by laboratory testing from our own and independent ceramic test houses. Johnson Tiles are British Standard registered and all products conform to the standards set in BS EN 14411.

For the reassurance of single-source supply, Johnson Tiles offers a free of charge NBS M40 specification writing service featuring the Norcros Adhesives range of tile fixing products. To find out more or for any questions or queries relating to any tile related technical information featured in this product presenter, please contact our technical advice helpline on +44 (0)1782 524 111 or email ddunlop@johnson-tiles.com

The colours shown in this sample tile wallet and attached booklet are as accurate as printing processes will allow. Please refer to actual product samples before specifying. Every effort has been made to ensure the accuracy of the information given.

For more information about **Danube** or any
of our other product ranges simply visit

www.johnson-tiles.com |       

Where To Find & Contact Us

Johnson Tiles Head Office

Harewood Street, Tunstall,
Stoke on Trent, Staffordshire,
ST6 5JZ, United Kingdom

Tel: +44 (0)1782 575 575
Email: info@johnson-tiles.com
www.johnson-tiles.com

Material Lab Studio

10 Great Titchfield Street,
London, W1W 8BB,
United Kingdom

Tel: +44 (0)20 7436 8629
Email: info@material-lab.co.uk
www.material-lab.co.uk

Johnson Tiles Factory Outlet

Tel: +44 (0)1782 524 040
Email: foutlet@johnson-tiles.com
www.outlet.johnson-tiles.com

Customer Services

Tel: +44 (0)1782 524 000
Email: sales@johnson-tiles.com

Order A Sample

Tel: +44 (0)1782 524 043
Email: samples@johnson-tiles.com

Technical Advice

Tel: +44 (0)1782 524 111
Email: ddunlop@johnson-tiles.com

Launched: May 2023

www.johnson-tiles.com |       

JOHNSON • TILES 
MADE IN THE UK SINCE 1901

Johnson Tiles is a division of Norcros Group (Holdings) Limited,
Ladyfield House, Station Road, Wilmslow, Cheshire, SK9 1BU,
United Kingdom. Registered in England number 566694.